

**APOLLO SUPPLIED-AIR RESPIRATOR
Helmet Model 60
Low Pressure 6 psi to 20 psi
O. M. 22084**

**MC FILE NUMBER: 2039-0997
DATE OF ISSUE: October, 1997
REVISION: H, 01/11**

 WARNING

Do not proceed with these instructions until you have READ the orange cover of this MANUAL and YOU UNDERSTAND its contents. *

These WARNINGS are included for the health and safety of the operator and those in the immediate vicinity.

***If you are using a Clemco Distributor Maintenance and Part Guide, refer to the orange warnings insert preceding the Index before continuing with the enclosed instructions.**

Electronic files include a Preface containing the same important information as the orange cover.

NOTICE

This supplied air respirator conforms to all NIOSH specifications and standards and carries NIOSH approval. As manufactured, this respirator complies only with those foreign approvals that accept NIOSH certification. Specifically, it has not been manufactured to European CE standards and does not carry the European CE-mark.

© 2011 CLEMCO INDUSTRIES CORP.

One Cable Car Dr.
Washington, MO 63090
Phone (636) 239-4300
Fax (800) 726-7559

Email: info@clemcoindustries.com
www.clemcoindustries.com



⚠ WARNING

- Read and follow ALL instructions before using this equipment.
- Failure to comply with ALL instructions can result in serious injury or death.
- In the event that the user, or any assistants of the user of this equipment cannot read or cannot completely understand the warnings and information contained in these instructions, the employer of the user and his assistants must thoroughly educate and train them on the proper operation and safety procedures of this equipment.

NOTICE TO PURCHASERS AND USERS OF OUR PRODUCTS AND THIS INFORMATIONAL MATERIAL

The products described in this material, and the information relating to those products, is intended for knowledgeable, experienced users of abrasive blasting equipment.

No representation is intended or made as to the suitability of the products described herein for any particular purpose or application. No representations are intended or made as to the efficiency, production rate, or the useful life of the products described herein. Any estimate regarding production rates or production finishes are the responsibility of the user and must be derived solely from the user's experience and expertise, and must not be based on information in this material.

The products described in this material may be combined by the user in a variety of ways for purposes determined solely by the user. No representations are intended or made as to the suitability or engineering balance of the combination of products determined by the user in his selection, nor as to the compliance with regulations or standard practice of such combinations of components or products.

Abrasive Blast Equipment is only a component of the range of equipment used in an abrasive blasting job. Other products may include an air compressor, abrasive, scaffolding, hydraulic work platforms or booms, paint spray equipment, dehumidification equipment, air filters and receivers, lights, ventilation equipment, parts handling equipment, specialized respirators, or equipment that while offered by Clemco may have been supplied by others. Each manufacturer and supplier of the other products used in the abrasive blasting job must be contacted for information, training, instruction and warnings with regard to the proper and safe use of their equipment in the particular application for which the equipment is being used. The information provided by Clemco is intended to provide instruction only on Clemco products. All operators must be trained in the proper, safe, use of this equipment. It is the responsibility of the users to familiarize themselves with, and comply with, all appropriate laws, regulations, and safe practices that apply to the use of these products. Consult with your employer about training programs and materials that are available.

Our company is proud to provide a variety of products to the abrasive blasting industry, and we have confidence that the professionals in our industry will utilize their knowledge and expertise in the safe efficient use of these products.

GENERAL INSTRUCTIONS

Described herein are some, **BUT NOT ALL**, of the major requirements for safe and productive use of blast machines, remote control systems, operator respirator assemblies, and related accessories. Completely read **ALL** instruction manuals prior to using equipment.

The user's work environment may include certain **HAZARDS** related to the abrasive blasting operation. Proper protection for the blaster, as well as anyone else that may be **EXPOSED** to the hazards generated by the blasting process, is the responsibility of the user and/or the employer. Operators **MUST** consult with their employer about what hazards may be present in the work environment including, but not limited to, exposure to dust that may contain **TOXIC MATERIALS** due to the presence of silica, cyanide, arsenic or other toxins in the abrasive, or materials present in the surface to be blasted such as lead or heavy metals in coatings. The environment may also include fumes that may be present from adjacent coatings application, contaminated water, engine exhaust, chemicals, and asbestos. The work area may include **PHYSICAL HAZARDS** such as an uneven work surface, poor visibility, excess noise, and electrical hazards. The operator **MUST** consult with his employer on the identification of potential hazards, and the appropriate measures that **MUST** be taken to protect the blaster and others that might be exposed to these hazards.

ALL machines, components and accessories **MUST** be installed, tested, operated and maintained only by trained, knowledgeable, experienced users.

DO NOT modify or substitute any Clemco parts with other types or brands of equipment. Unauthorized modification and parts substitution on supplied air respirators is a violation of OSHA regulations and voids the NIOSH approval.

OPERATIONAL INSTRUCTIONS

OPERATOR SAFETY EQUIPMENT

⚠ WARNING

- Blast operators and others working in the vicinity of abrasive blasting must always wear properly-maintained, NIOSH-approved, respiratory protection appropriate for the job site hazards.
- **DO NOT USE** abrasives containing more than one percent crystalline (free) silica. Ref. NIOSH Alert #92-102
- Inhalation of toxic dust (crystalline silica, asbestos, lead paint and other toxins) can lead to serious or fatal disease (silicosis, asbestosis, lead or other poisoning).

- **ALWAYS** wear NIOSH-approved supplied-air respirators as required by OSHA, in the presence of any dust including, but not limited to, handling or loading abrasive; blasting or working in the vicinity of blast jobs; and cleanup of expended abrasive. Prior to removing respirator, an air monitoring

instrument should be used to determine when surrounding atmosphere is clear of dust and safe to breathe.

- NIOSH-approved, supplied-air respirators are to be worn ONLY in atmospheres:
 - NOT IMMEDIATELY dangerous to life or health and,
 - from which a user can escape WITHOUT using the respirator.
- Clemco supplied-air respirators **DO NOT REMOVE OR PROTECT AGAINST CARBON MONOXIDE (CO) OR ANY OTHER TOXIC GAS.** Carbon monoxide and toxic gas removal and/or monitoring device must be used in conjunction with respirator to insure safe breathing air.
- Air supplied to respirator **MUST BE AT LEAST GRADE D QUALITY** as described in Compressed Gas Association Commodity Specification G-7.1, and as specified by OSHA Regulation 1910.139 (d).
- ALWAYS locate compressors to prevent contaminated air (such as CO from engine exhaust) from entering the air intake system. A suitable in-line air purifying sorbent bed and filter or CO Monitor should be installed to assure breathing air quality.
- ALWAYS use a NIOSH-approved breathing air hose to connect an appropriate air filter to the respirator. Use of a non-approved air hose can subject the operator to illness caused by the release of chemical agents used in the manufacture of non-approved breathing air hose.
- ALWAYS check to make sure air filter and respirator system hoses are NOT CONNECTED to in-plant lines that contain nitrogen, acetylene or any other non-breathable gas. NEVER use oxygen with air line respirators. NEVER modify air line connections to accommodate air filter/respirator breathing hose WITHOUT FIRST testing content of the air line. **FAILURE TO TEST THE AIR LINE MAY RESULT IN DEATH TO THE RESPIRATOR USER.**
- Respirator lenses are designed to protect against rebounding abrasive. They do not protect against flying objects, glare, liquids, radiation or high speed heavy materials. Substitute lenses from sources other than the original respirator manufacturer will void NIOSH-approval of this respirator.

BLAST MACHINES AND REMOTE CONTROLS

 WARNING
<ul style="list-style-type: none"> • ALWAYS equip abrasive blast machines with remote controls. • Abrasive blast machine operators must wear NIOSH-approved supplied-air respirators (ref: OSHA regulations 1910.94, 1910.132, 1910.139 and 1910.244).

- NEVER modify OR substitute remote control parts. Parts from different manufacturers are NOT compatible with Clemco

equipment. If controls are altered, involuntary activation, which may cause serious injury, can occur.

- Inspect the air control orifice DAILY for cleanliness. NEVER use welding hose in place of twinline control hose. The internal diameter and rubber composition are UNSAFE for remote control use.
- UNLESS OTHERWISE SPECIFIED, maximum working pressure of blast machines and related components MUST NOT exceed National Board approved 125 psig (8.5 BAR).
- NEVER weld on blast machine. Welding may affect dimensional integrity of steel wall and WILL VOID National Board approval.
- Point nozzle ONLY at structure being blasted. High velocity abrasive particles WILL inflict serious injury. Keep unprotected workers OUT of blast area.
- NEVER attempt to manually move blast machine when it contains abrasive. EMPTY machines, up to 6 cu. ft.(270kg) capacity, are designed to be moved:
 - on flat, smooth surfaces by AT LEAST two people;
 - with the Clemco "Mule"; or
 - with other specially designed machine moving devices.
- Larger empty blast machines or ANY blast machine containing abrasive MUST be transported by mechanical lifting equipment.

AIR HOSE, BLAST HOSE, COUPLINGS, AND NOZZLE HOLDERS

- Air hose, air hose fittings and connectors at compressors and blast machines MUST be FOUR times the size of the nozzle orifice. Air hose lengths MUST be kept as short as possible AND in a straight line. Inspect DAILY and repair leakage IMMEDIATELY.
- Blast hose inside diameter MUST be THREE to FOUR times the size of the nozzle orifice. AVOID sharp bends that wear out hose rapidly. Use SHORTEST hose lengths possible to reduce pressure loss. Check blast hose DAILY for soft spots. Repair or replace IMMEDIATELY.
- ALWAYS cut loose hose ends square when installing hose couplings and nozzle holders to allow uniform fit of hose to coupling shoulder. NEVER install couplings or nozzle holders that DO NOT provide a TIGHT fit on hose. ALWAYS use manufacturers recommended coupling screws.
- Replace coupling gaskets FREQUENTLY to prevent leakage. Abrasive leakage can result in dangerous coupling failure. ALL gaskets MUST be checked SEVERAL times during a working day for wear, distortion and softness.
- Install safety pins at EVERY coupling connection to prevent accidental disengagement during hose movement.
- ALWAYS attach safety cables at ALL air hose AND blast hose coupling connections. Cables relieve tension on hose and control whipping action in the event of a coupling blow-out.

MAINTENANCE

- ALWAYS shut off compressor and depressurize blast machine BEFORE doing ANY maintenance.
- Always check and clean ALL filters, screens and alarm systems when doing any maintenance.
- ALWAYS cage springs BEFORE disassembling valves IF spring-loaded abrasive control valves are used.
- ALWAYS completely follow owner's manual instructions and maintain equipment at RECOMMENDED intervals.

ADDITIONAL ASSISTANCE

- Training and Educational Programs. Clemco Industries Corp. offers a booklet, Blast-Off 2, developed to educate personnel on abrasive blast equipment function and surface preparation techniques. Readers will learn safe and productive use of machines, components and various accessories, including selection of abrasive materials for specific surface profiles and degrees of cleanliness.
- The Society for Protective Coatings (SSPC) offers a video training series on protective coatings including one entitled "Surface Preparation." For loan or purchase information, contact SSPC at the address shown below.

TECHNICAL DATA AND RESEARCH COMMITTEES

- The following associations offer information, materials and videos relating to abrasive blasting and safe operating practices.

The Society for Protective Coatings (SSPC)
 40 24th Street, Pittsburgh PA 15222-4643
 Phone: (412) 281-2331 • FAX (412) 281-9992
 Email: research@sspc.org • Website: www.sspc.org

National Association of Corrosion Engineers (NACE)
 1440 South Creek Drive, Houston TX 77084
 Phone: (281) 228-6200 • FAX (281) 228-6300
 Email: msd@mail.nace.org • Website: www.nace.org

American Society for Testing and Materials (ASTM)
 100 Barr Harbor Dr., West Conshohocken, PA 19428
 Phone (610) 832-9500 • FAX (610) 832-9555
 Email: service@astm.org • Website: www.astm.org

NOTICE

This equipment is not intended to be used in an area that might be considered a hazardous location as described in the National Electric Code NFPA 70 1996, article 500.

WARRANTY

The following is in lieu of all warranties express, implied or statutory and in no event shall seller or its agents, successors, nominees or assignees, or either, be liable for special or consequential damage arising out of a breach of warranty. This warranty does not apply to any damage or defect resulting from negligent or improper assembly or use of any item by the buyer or its agent or from alteration or attempted repair by any person other than an authorized agent of seller. All used, repaired, modified or altered items are purchased "as is" and with all faults. In no event shall seller be liable for consequential or incidental damages. The sole and exclusive remedy of buyer for breach of warranty by seller shall be repair or replacement of defective parts or, at seller's option, refund

- of the purchase price, as set forth below:
1. Seller makes no warranty with respect to products used other than in accordance hereunder.
 2. On products seller manufactures, seller warrants that all products are to be free from defects in workmanship and materials for a period of one year from date of shipment to buyer, but no warranty is made that the products are fit for a particular purpose.
 3. On products which seller buys and resells pursuant to this order, seller warrants that the products shall carry the then standard warranties of the manufacturers thereof, a copy of which shall be made available to customer upon request.
 4. The use of any sample or model in connection with this order is for illustrative purposes only and is not to be construed as a warranty that the product will conform to the sample or model.
 5. Seller makes no warranty that the products are delivered free of the rightful claim of any third party by way of patent infringement or the like.
 6. This warranty is conditioned upon seller's receipt within ten (10) days after a buyer's discovery of a defect, of a written notice stating in what specific material respects the product failed to meet this warranty. If such notice is timely given, seller will, at its option, either modify the product or part to correct the defect, replace the product or part with complying products or parts, or refund the amount paid for the defective product, any one of which will constitute the sole liability of seller and a full settlement of all claims. No allowance will be made for alterations or repairs made by other than those authorized by seller without the prior written consent of seller. Buyer shall afford seller prompt and reasonable opportunity to inspect the products for which any claim is made as above stated.

Except as expressly set forth above, all warranties, express, implied or statutory, including implied warranty of merchantability, are hereby disclaimed.

DAILY SET-UP CHECK LIST

 WARNING
<ul style="list-style-type: none"> • ALL piping, fittings and hoses MUST be checked DAILY for tightness and leakage. • ALL equipment and components MUST be thoroughly checked for wear. • ALL worn or suspicious parts MUST be replaced. • ALL blast operators MUST be properly trained to operate equipment. • ALL blast operators MUST be properly outfitted with abrasive resistant clothing, safety shoes, leather gloves and ear protection. • BEFORE blasting ALWAYS use the following check list.

1. PROPERLY MAINTAINED AIR COMPRESSOR sized to provide sufficient volume (cfm) for nozzle and other tools PLUS a 50% reserve to allow for nozzle wear. Use large compressor outlet and large air hose (4 times the nozzle orifice size). FOLLOW MANUFACTURERS MAINTENANCE INSTRUCTIONS.

2. BREATHING AIR COMPRESSOR (oil-less air pump) capable of providing Grade D Quality air located in a dust free, contaminant free area. If oil-lubricated air compressor is used to supply respirator, it should have high temperature monitor and CO monitor or both. If CO monitor is not used, air **MUST** be tested FREQUENTLY to ensure proper air quality.

3. Clean, properly maintained NIOSH-APPROVED SUPPLIED-AIR RESPIRATOR. ALL components should ALWAYS be present. NEVER operate without inner lens in place. Thoroughly inspect ALL components DAILY for cleanliness and wear. ANY substitution of parts voids NIOSH approval i.e. cape, lenses, breathing hose, breathing air supply hose, air control valve, cool air or climate control devices.

4. OSHA required BREATHING AIR FILTER for removal of moisture and particulate matter from breathing air supply. THIS DEVICE DOES NOT REMOVE OR DETECT CARBON MONOXIDE (CO). ALWAYS USE CO MONITOR ALARM.

5. ASME CODED BLAST MACHINE sized to hold 1/2 hour abrasive supply. ALWAYS ground machine to eliminate static electricity hazard. Examine pop up valve for alignment. Blast machine MUST be fitted with a screen to keep out foreign objects and a cover to prevent entry of moisture overnight.

6. AIR LINE FILTER installed AS CLOSE AS POSSIBLE to machine inlet. Sized to match inlet piping or larger air supply line. Clean filter DAILY. Drain OFTEN.

7. REMOTE CONTROLS MUST be in PERFECT operating condition. ONLY use APPROVED spare parts, including twin-line hose. DAILY: test system operation and check button bumper and spring action of lever and lever lock. DO NOT USE WELDING HOSE.

8. BLAST HOSE with ID 3 to 4 times the nozzle orifice. Lines MUST be run AS STRAIGHT AS POSSIBLE from machine to work area with NO sharp bends. Check DAILY for internal wear and external damage.

9. HOSE COUPLINGS, NOZZLE HOLDERS fitted SNUGLY to hose end and installed using PROPER coupling screws. Coupling lugs MUST be snapped FIRMLY into locking position. Gasket MUST form positive seal with safety pins inserted through pin holes. Check gaskets and replace if ANY sign of wear, softness or distortion. ALWAYS install safety cables at every connection to prevent disengagement. Check nozzle holder for worn threads. NEVER MIX DIFFERENT BRANDS OF COMPONENTS. Check each of these components DAILY.

10. Inspect NOZZLE and GASKET DAILY for wear. Replace nozzle when 1/16" larger than original size or if liner appears cracked. Check nozzle threads for wear.

11. Use abrasive that is properly sized and free of harmful substances; such as, free silica, cyanide, arsenic or lead. Check material data sheet for presence of toxic or harmful substances.

12. Test surface to be blasted for toxic substances. Take appropriate, and NIOSH required, protective measures for operator and bystanders which pertain to substances found on the surface to be blasted.

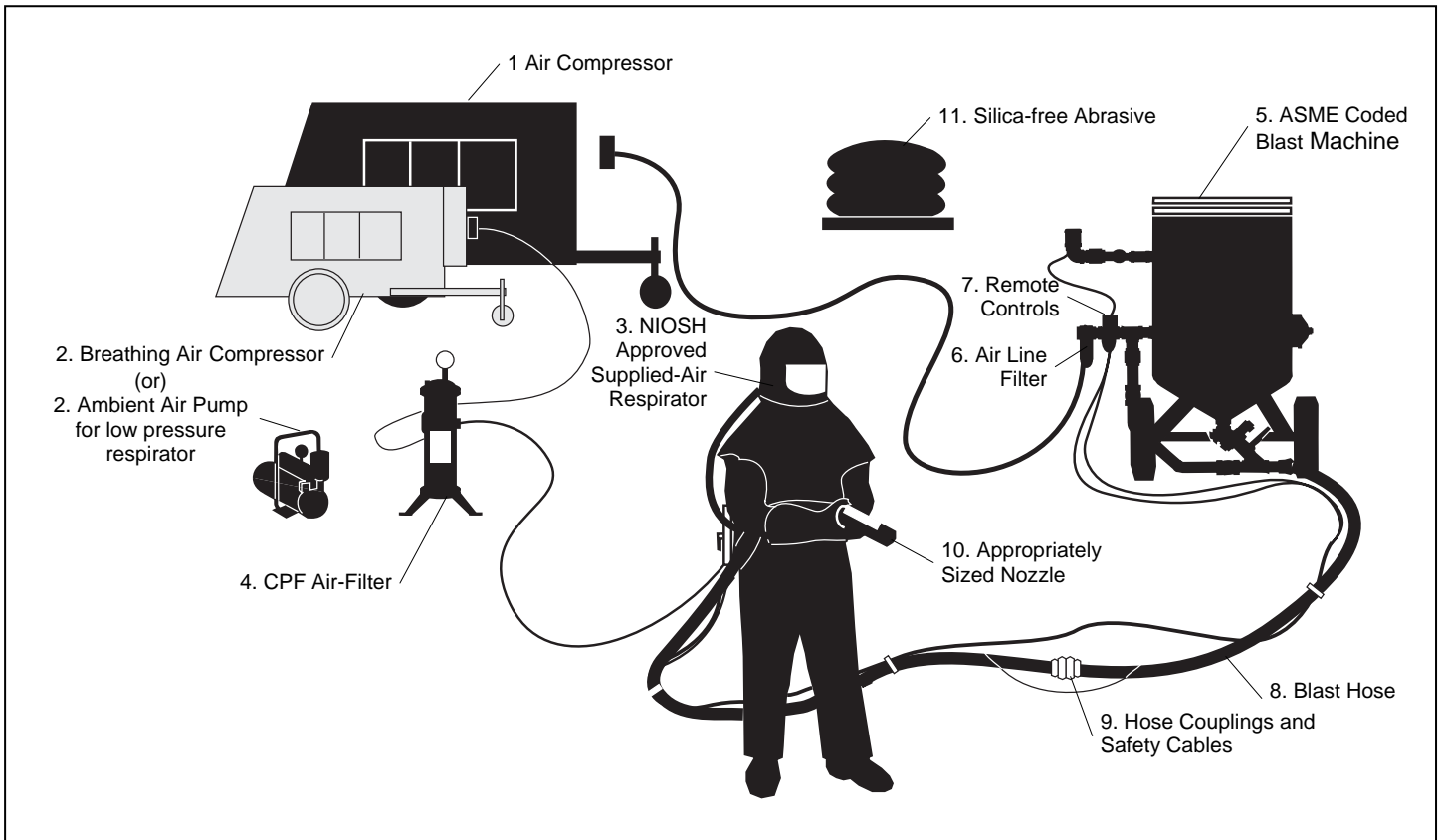

1.0 INTRODUCTION

1.1 Scope of manual

1.1.1 This manual covers setup, operation, maintenance, and replacement parts for Clemco Apollo LP (low pressure) Series Supplied-Air Respirator: Model 60 LP.

1.1.2 Read this entire manual and all accessory manuals before setting-up and using the respirator. Manuals for Clemco low pressure, ambient air pumps that may be used with Apollo LP Respirators are available on our web site, www.clemcoindustries.com. Refer to Figure 1 for a typical set-up.

1.2 Safety Alerts

1.2.1 Clemco uses safety alert signal words, based on ANSI Z535.4-1998, to alert the user of a potentially hazardous situation that may be encountered while operating this equipment. ANSI's definitions of the signal words are as follows:



This is the safety alert symbol. It is used to alert the user of this equipment of potential personal injury hazards.

Obey all safety messages that follow this symbol to avoid possible injury or death.

CAUTION

Caution used without the safety alert symbol indicates a potentially hazardous situation which, if not avoided, may result in property damage.

CAUTION

Caution indicates a potentially hazardous situation which, if not avoided, may result in minor or moderate injury.

WARNING

Warning indicates a potentially hazardous situation which, if not avoided, could result in death or serious injury.

DANGER

Danger indicates an imminently hazardous situation which, if not avoided, will result in death or serious injury.

1.3 NIOSH Approval Number 19C-358

1.3.1 The Clemco Apollo Supplied-Air Respirator is approved by the National Institute of Occupational Safety and Health (NIOSH).

1.3.2 The NIOSH label shown below lists the Apollo respirator approval number. An X on the approval line indicates which components are approved for the specific respirator. Do not use any non-approved components with this respirator.



Clemco Industries Corp.
Washington MO, USA
(636) 239-0300



TYPE C AND CE CONTINUOUS FLOW SUPPLIED-AIR RESPIRATOR IS APPROVED ONLY IN THE FOLLOWING CONFIGURATIONS:

TC#	Protection ¹	Model	Respirator Components										Cautions and Limitations ²					
			Helmets		Alternate Regulators				Hose Air Lines									
			Part No.	Model	CAT	CCT	Clem-Cool A/C	CFC/High Pressure	CFC/Low Pressure	ACV	Yellow 3/8" x 25 Ft.	Yellow 3/8" x 50 Ft.		Yellow 3/8" x 100 Ft.	Black 1/2" x 100 Ft.	Black 1/2" x 50 Ft.		
19C-338	CF/SA	20HP	10506	Apollo 60														ABCDEJMNOS
19C-339	CF/SA	20LP	23824	Apollo 600	x													ABCDEJMNOS
19C-130	CF/SA	60/600HP	21302	Apollo 20		x												ABCDEJMNOS
19C-358	CF/SA	60/600LP	04410	CAT			x											ABCDEJMNOS
			23825	CCT				x										
			21422	Clem-Cool A/C					x									
			21777	CFC/High Pressure						x								
			100024	CFC/Low Pressure							x							
			04397	ACV								x						
			04415	Yellow 3/8" x 25 Ft.									x					
			04398	Yellow 3/8" x 50 Ft.										x				
			21413	Yellow 3/8" x 100 Ft.											x			
			22510	Black 1/2" x 100 Ft.												x		
			22510	Black 1/2" x 50 Ft.													x	

1 PROTECTION
CF - Continuous Flow SA - Supplied -air

2 CAUTIONS AND LIMITATIONS

A- Not for use in atmospheres containing less than 19.5 percent oxygen.
 B- Not for use in atmospheres immediately dangerous to life or health.
 C- Do not exceed maximum use concentrations established by regulatory standards.
 D- Air-line respirators can be used only when the respirators are supplied with respirable air meeting the requirements of CGA G-7.1 Grade D or higher quality.
 E- Use only the pressure ranges and hose lengths specified in the user's instructions.
 J- Failure to properly use and maintain this product could result in injury or death.
 M- All approved respirators shall be selected, fitted, used, and maintained in accordance with MSHA, OSHA, and other applicable regulations.
 N- Never substitute, modify, add, or omit parts. Use only exact replacement parts in the configuration as specified by the manufacturer.
 O- Refer to users instructions, and/or maintenance manuals for information on use and maintenance of these respirators.
 S-Special or critical users instructions, and/or specific use limitations apply. Refer to instruction manual before donning.

⚠ WARNING

NIOSH approval applies only when this supplied-air respirator is used as a complete system. Do not make any non-approved modification, deletion, or substitution. Non-approved components void the NIOSH approval and may permit ingress of toxic and hazardous dust, resulting in toxic poisoning and respiratory disease.

1.4 OSHA Regulations

1.4.1 OSHA Regulation 29 CFR 1910.134 for respiratory protection in General Industry is referenced throughout this document. Respiratory protection standards for Construction 29 CFR 1926.103 and for Maritime 29 CFR-1915.154, 1917, and 1918 refer back to 1910.134. The complete regulation is available through the U.S. Dept. of Labor web site at www.osha.gov.

1.4.2 OSHA Regulations 29 CFR 1910.134(a) and (c) require the employer to establish and maintain a comprehensive, written, respiratory protection program administered by a suitably-trained program administrator.

1.4.3 It is essential that the user be properly instructed in the use and maintenance of the respirator. This manual must be made available to all users of the respirator, and the users must demonstrate their understanding of its subject matter. Read the entire manual before installing or operating the equipment.

1.4.4 The respirator must be supplied with respirable air meeting requirements described herein. It is the responsibility of the employer to provide quality breathing-air to the respirator, and to establish a program to ensure that the respirator is properly used and maintained.

1.5 Respiratory and Health Alerts

⚠ WARNING

TOXIC DUST POISONING

Research by the National Institute For Occupational Safety and Health (NIOSH) has discovered risks associated with dust produced during abrasive blasting operations including but not limited to Lead, Silica, Antimony, Arsenic, Beryllium, Cadmium, Chromium, Cobalt, Nickel, Tin, Nitrate and Nitrite, to unprotected abrasive

blasting operators and other personnel who may be exposed to toxic dust in the abrasive blasting vicinity. These risks include debilitating lung, blood, liver, kidney, and skin injuries, and even death. Toxic dust is produced primarily by the breakdown of the abrasive being used and the surface being treated, during abrasive blasting.

The breakdown of toxic coatings and hazardous abrasive causes the contaminants to become airborne. Breathing toxic dust generated by the abrasive or surface being treated can cause health and life-threatening toxic poisoning and can damage vital organs. Breathing hazardous dust produced from silica and other abrasives can cause delayed life-threatening respiratory disease.

It is imperative that blasting contractors identify all material being removed by blasting, and obtain material safety data sheets (MSDS) for the blasting abrasive prior to blasting. It is the responsibility of the employer to identify all airborne contaminants in the blast vicinity, and ensure they do not exceed the permissible exposure limit (PEL) Ref. 29 CFR 1910.1000 and 29 CFR 1926.62. Thorough site hazard examinations should be made by A Certified Industrial Hygienist, Certified Safety Professional or other qualified professional to identify all contaminants generated by blasting and in the blasting vicinity.

Exposure to dangerous levels of toxic or hazardous dust is not restricted to blast operators. There may be an equal or greater danger present after the blasting process due to lingering airborne dust particles, and especially from dust generated during cleanup activity. Heavy metal paint, asbestos, sand or other silica, and other toxic material dusts will cause serious lung disease or death if not prevented through the use of properly designed, and maintained NIOSH-approved, supplied-air respirators worn by blasting operators and all personnel within the work area. OSHA's regulations found primarily in 29CFR1910, Subpart Z provides the permissible exposure limits for all toxic and hazardous substances. It is the responsibility of the employer to determine the inhalation hazards associated with the abrasive blasting being performed. Do not begin any operations including abrasive blasting without being trained by the employer and fully understanding the hazards associated with the work performed.

The Apollo supplied-air respirator system is approved by NIOSH as a Type-CE, continuous-flow, abrasive blast, supplied-air respirator, in

accordance with title 42 CFR Part 84. The NIOSH recognized assigned protection factor (APF) for any supplied-air respirator equipped with a loose-fitting hood or helmet and operated in a continuous flow mode is 25, based upon the NIOSH Respirator Decision Logic (Pub. No. 87-108). In other words, any Type-CE respirator should be used only in atmospheres in which the contaminant level does not exceed 25 times the permissible exposure limit. However, OSHA revised its existing Respiratory Protection standard in 2006 to add APFs and Maximum Use Concentration (MUC) provisions. APF means the workplace level of respiratory protection that a respirator or class of respirators is able to provide to workers. OSHA placed a table reflecting the appropriate APF for various respirators in 29CFR 1910.134(d)(3)(i)(A). OSHA also provides a free publication titled "Assigned Protection Factors" (reference number "OSHA 3352-02 2009") to assist the user and their employer in understanding the selection of respirators based on APFs and MUCs. This section of the OSHA regulations allow the employer to assign an APF of 1000 to all Apollo Series Respirators based on the simulated workplace protection factor studies Clemco has performed. These studies are available for download from Clemco's Website www.clemcoindustries.com, under the "Safety Info" tab

The employer must provide and maintain appropriate approved respirators, in addition to providing operator training and employing required work site safety practices.

To avoid any potential danger of respiratory injury, approved, supplied-air respirators must be worn at all times in the presence of any type of dust. The respirator must be maintained as described herein. Improper use of any respirator may cause life threatening respiratory disease, and immediate poisoning from toxic dust. Respirators should be removed only after the ambient air has been tested with a dust monitor, and found to be safe to breathe.

Toxic dust poisoning also may occur by eating, drinking, or smoking in a contaminated area, or by eating, drinking, or smoking in a non-hazardous area before thorough washing of hands and face. Do not eat, drink or smoke in the blast area. Thoroughly wash hands and face to remove contaminants before eating, drinking, or smoking outside the blast area.

This manual does not contain all the health and safety requirements regarding toxic and hazardous dust exposure. Obtain copies of the OSHA regulations and consult a safety professional and/or industrial hygienist for complete requirements.

Within this manual we refer to hazardous or contaminated environments. These environments can be any places around the blast area that could contain toxic or hazardous dust.

If these warnings are not completely understood, or if further information is required, contact a local OSHA office. If any personnel in the abrasive blasting vicinity cannot read or comprehend these warnings and the entire content of this instructional material, assign a qualified person to instruct him/her.

Additional information on abrasive blasting hazards titled "Preventing Silicosis and Death From Sandblasting", Publication No. 92-102, is available from:

Publications Dissemination, DSDTT
National Institute for Occupational Safety and Health
4676 Columbia Parkway
Cincinnati, OH 45226 (513) 533-8287

1.6 Cautions and Limitations

A - Not for use in atmospheres containing less than 19.5 percent oxygen.

B - Not for use in atmospheres immediately dangerous to life or health (IDLH).

C - Do not exceed maximum use concentrations established by regulatory standards.

D - Air-line respirators can be used only when the respirators are supplied with respirable air meeting the requirements of CGA G-7.1 for Grade D or higher quality.

E - Use only the pressure ranges and hose lengths specified in the user's instructions.

J - Failure to properly use and maintain this product could result in injury or death.

M - All approved respirators shall be selected, fitted, used, and maintained in accordance with OSHA and other applicable regulations.

N - Never substitute, modify, add, or omit parts. Use only exact replacement parts in the configuration as specified by the manufacturer.

O - Refer to user's instructions, and/or maintenance manuals for information on use and maintenance of these respirators.

S - Special or critical user's instructions, and/or specific use limitations apply. Refer to instruction manual before donning.

1.7 S – Special or Critical User's Instructions

1.7.1 Air pressure at the point of attachment (the point of attachment is where the respirator supply hose is connected to the respirable air source) must be maintained at pressures between the minimum and maximum pressure as shown in the table in Section 4.2.

WARNING

Failure to maintain the minimum pressure at the point of attachment may reduce air flow below the minimum flow required by OSHA. Reduced air flow may result in ingress of hazardous toxic dust, subjecting the user to immediate health and life threatening poisoning and subsequent respiratory disease.

1.7.2 Couple no more than the maximum number of sections and total maximum lengths of respirator hose as noted in the table in Section 4.2.

1.7.3 The respirator is designed for specific use in abrasive blasting applications. Do not use in other operations such as painting or welding.

1.8 Protection

1.8.1 NIOSH recognized Assigned Protection Factor (APF) for the Apollo type CE respirator is 25 times the permissible exposure limit (PEL). In other words, NIOSH recommends the Apollo type CE respirators should only be used in atmospheres in which the contaminant level does not exceed 25 times the PEL. However OSHA's 2006 revised Respirator Standard allows an exception for type CE respirators which have validated third party testing for use up to 1000 APF. In order not to be in violation of OSHA 1000 APF the end-user must have a copy of this validated testing. A copy of Clemco validated testing may be downloaded from the "Safety Info" tab on our website, www.clemcoindustries.com.

1.8.2 Head: The respirator protects the wearer's head and neck from impact and from abrasion caused by rebounding abrasive. The respirator meets physical requirements for industrial head protection as stated in ANSI Z89.1-1997 as a Type I, Class G protective helmet.

1.8.3 Face and Eye: The Apollo inner lens meets impact and penetration requirements under ANSI Z87.1-1989.

1.8.4 Hearing: Noise generated by the Apollo respirator, and measured inside the helmet does not exceed 80 decibels. (42 CFR part 84.140) When any exterior noise causes the internal noise level to exceed 80 decibels, the user must wear additional hearing protection. A variety of hearing protectors can be worn with the respirator.

2.0 INSPECTION

NOTE: A Clemco respirator hose is part of the approval assembly, and must be used with the respirator. Hoses are not included with all respirators because blast operators are often assigned personal respirators, while using common respirator hoses. If a hose is not available, it must be ordered from an authorized distributor of Clemco products.

2.1 Component Checklist

2.1.1 Make sure that all the respirator components are present. Each respirator box should contain the following:

- Helmet with chin strap, suspension and cape attached
- Breathing tube assembly
- Constant-flow connector

NOTE: If the respirator does not include an approved Clemco respirator hose, and if one is not at the work site for use with the respirator, one or more alternate hoses must be ordered separately.

2.1.2 When all of these components are present, prepare the respirator for operation per Section 3.0.

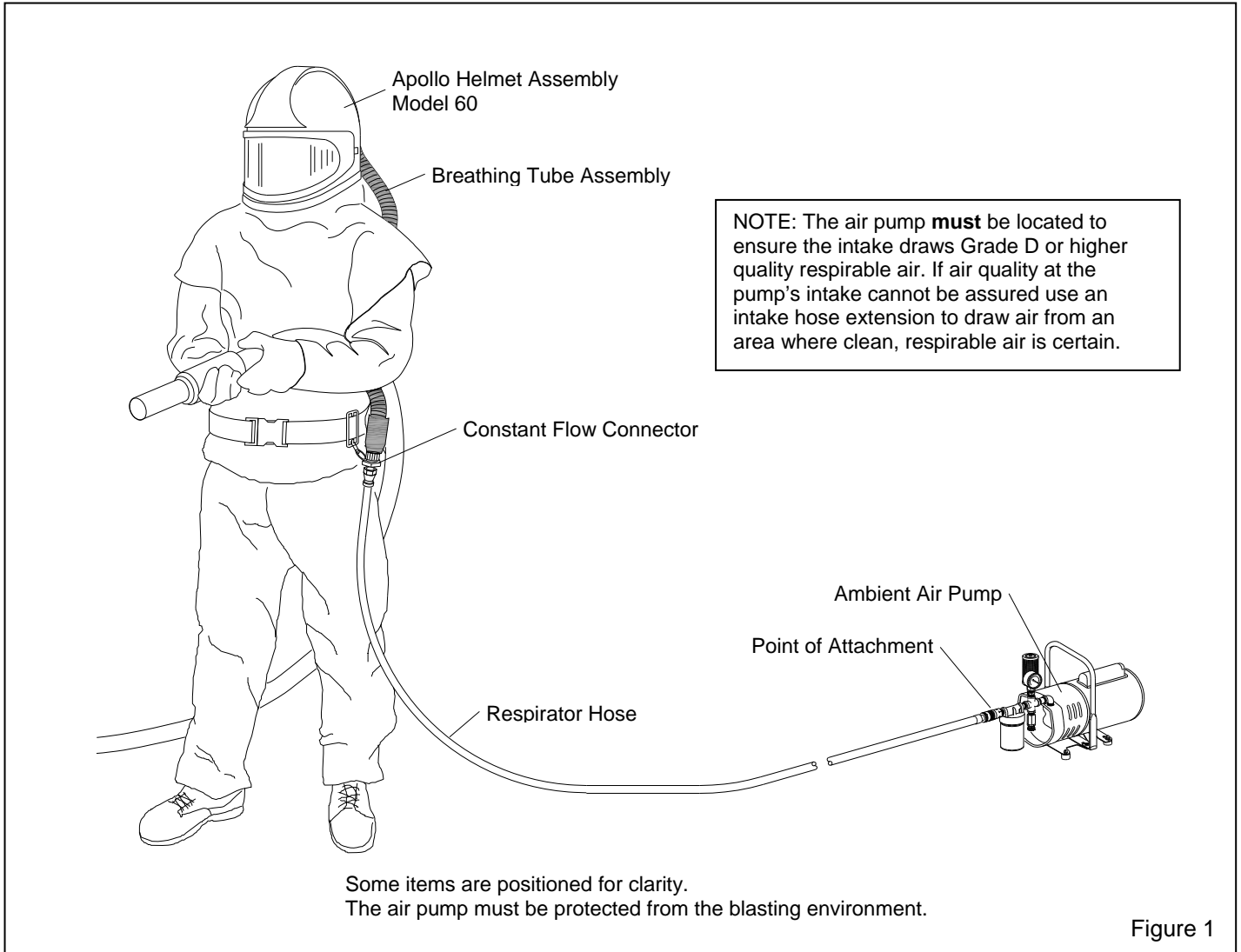

3.0 PREPARATION

3.1 Adjust Helmet Suspension per Section 6.1.

3.2 Prepare Lens System

⚠ WARNING

Never use the respirator without a complete lens system in place. A complete lens system includes the fixed inner lens, intermediate lens, and/or perforated outer lenses. The fixed, inner lens provides support for the window gasket. If the gasket is not adequately supported, leaks can occur which could permit entry of toxic and hazardous dust or abrasive into the helmet.

3.2.1 The lens system is an important part of the respirator assembly. The helmet is supplied with an inner lens that is secured by the lens gasket. To protect the inner lens, an optional intermediate lens and perforated outer lenses are securely held in position by the window frame. Always use an inner lens and one or both intermediate lens or perforated outer lens options with the respirator. The perforated outer lens protects the intermediate lens from rapid frosting. Both protect the inner lens.

3.2.2 When the perforated outer lenses are correctly installed, as one lens becomes frosted during blasting, it can be torn off to expose the next lens. To protect the inner lens, make sure the perforated and/or intermediate lens(es) are in place per Section 9.1.

3.3 Breathing Tube Assembly

⚠ CAUTION

Note the directional flow arrows on the labels at both ends of the breathing tube. The flow arrows indicate the direction of air flow to the helmet. Flow arrows must point toward the helmet. Failure to properly attach the breathing tube may damage the tube's acoustical foam, which will block air flow, or it may increase noise levels beyond OSHA limits.

3.3.1 The breathing tube has a clamped-on end and a molded-on end. Attach the clamped-on end to the threaded air inlet fitting at the back of the helmet as shown in Figure 2. Do not over-tighten; hand-tight is sufficient.

3.3.2 Attach the molded-on swivel connector to the constant-flow connector.

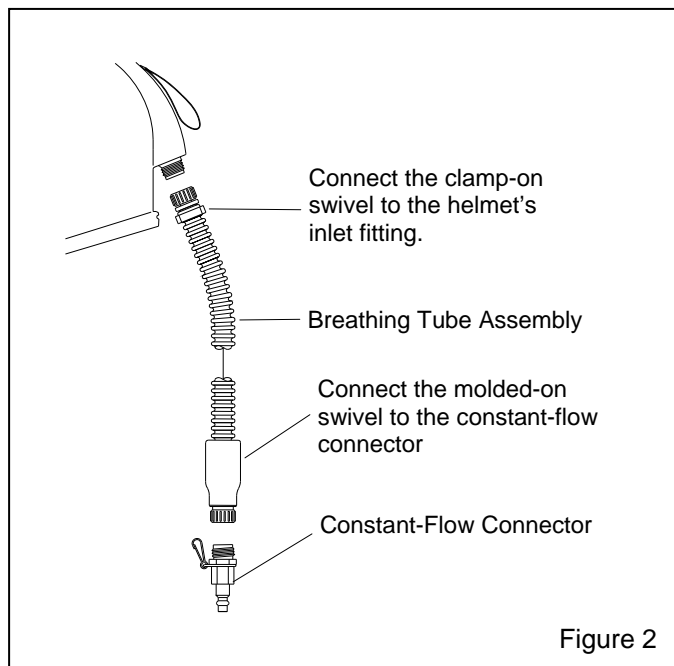

⚠ CAUTION

Use the strap handle to carry or hang the respirator. Never hold, carry or hang the respirator by the breathing tube. Mishandling the respirator in this manner may damage the tube or helmet inlet. Any leaks or breaks in the breathing tube will alter the air flow through the respirator and affect user's safety and comfort.

3.4 Respirator Hose

⚠ WARNING

OSHA regulations 29 CFR 1910 and 29 CFR 1926 require that respirator air line couplers be incompatible with air lines for non-respirable use. This incompatibility prevents inadvertent supply of respirators with potentially hazardous, non-respirable gases or oxygen. It is the employer's or facility owner's responsibility to comply with the regulation.

3.4.1 Respirator hose must be NIOSH-approved Clemco 1/2" ID respirator hose.

3.4.2 If longer hose is required, it must be a NIOSH-approved Clemco 1/2" respirator hose extension. Use 50-foot or 100-foot Clemco respirator hoses in any combination as noted in the table in Section 4.2, not to exceed 300 ft. or three individual hose lengths.

3.4.3 Attach the female disconnect end of the respirator hose to the constant-flow connector. The male end attaches to the ambient air pump.

3.5 CMS-3 CO Monitor Option, Respirator Mounted
The Clemco supplied air respirator model Apollo 60 LP is NIOSH approved with the accessory CMS-3 personal carbon monoxide alarm, but NIOSH has not evaluated the function of the CMS-3 personal carbon monoxide alarm.

3.5.1 Place the transparent mounting strip on the inside of the inner lens, and into the same window gasket groove as the inner lens. Position it so it is within peripheral vision toward the side of the window opening.

3.5.2 Remove backing from the Velcro[®] hook tape and adhere it to the center of the mounting strip (the loop tape adheres to the monitor).

3.5.3 Attach the monitor to the strip and don the helmet to make sure the monitor alarm light is visible from inside the helmet.

3.5.4 Remove the monitor and prepare it for operation per instructions supplied with the monitor.

3.5.5 Remove the monitor to do any service or calibration, including turning the monitor on and off. Do this to make sure the monitor is fully functional before placing it inside the helmet.

4.0 AIR SUPPLY

WARNING

Air supplied to this respirator system is critical to the safety of the user. Read this section carefully. Poor quality air or low air volume will cause serious respiratory injury or death to the user. See Toxic Dust Poisoning Warning in Section 1.5.

WARNING

This respirator is intended for use with (low pressure) ambient air pumps. Do not use compressors or high pressure cylinders (bottles) as an air source for this respirator. Air supplied from compressors poses hazards, especially from carbon monoxide that are not covered in these instructions. High pressure cylinders require special knowledge for their use and compliance, details of which are not covered in these instructions.

4.1 Air Quality

4.1.1 The quality of air supplied to the respirator is extremely critical to the safety of the user. Special care must also be taken to avoid accidental connection to any other gas lines; such as, oxygen, acetylene, or nitrogen.

DANGER

Never connect a breathing-air line to an air source that has not been tested for gas and particulate contamination. The presence of unacceptable levels of carbon monoxide (CO) or other gases, or oxygen deficiency in breathing air will cause death to the user.

4.1.2 The employer is responsible for ensuring that breathing air shall meet the requirements for Grade D or higher quality, as described in Compressed Gas Association Commodity Specification pamphlet G-7.1., titled Commodity Specification For Air, published by Compressed Gas Association Inc., Chantilly, VA. Website: www.cganet.com (29 CFR 1910.134 (i)).

4.1.3 Limiting characteristics of Grade D air, at the time of publication of this manual are as follows:

Carbon Dioxide	maximum of 1000 ppm
Carbon Monoxide	maximum of 10 ppm
Odor	*No pronounced odor
Oil (hydrocarbons)	maximum of 5 mg/m ³
Oxygen	between 19.5 - 23.5%

* Specific measurement of odor in gaseous air is impractical. Air may have a slight odor but the presence of a pronounced odor renders the air unsatisfactory.

4.1.4 Prior to using the respirator, read the owner's manual and all instructions, labels, and warnings relating to the ambient air pump.

WARNING

The air pump must be located where Grade D or higher quality respirable air is ensured. If air quality at the pump's intake cannot be assured, use an intake hose extension to draw air from an area where clean, respirable air is certain. Any toxic air entering the pump will enter the respirator and will cause severe illness or death to the user.

4.1.5 Take precautions to prevent contaminants from entering through the air pump's inlet filter. Locate the air pump's inlet filter away from all sources of contaminants including carbon monoxide, which is found in engine exhaust, and in any form of combustion. Place the pump in an area away from vehicle traffic. Do not locate the pump's inlet filter near any exhaust system outlet, ventilation flue, or source of fumes or particles of any kind. If the ambient air pump cannot be placed in an area where respirable air can be guaranteed, use an air inlet extension hose as specified by the pump manufacturer to bring air from an area where clean respirable air is ensured.

S – Special or Critical User's Instructions

4.2 Air Volume and Pressure

4.2.1 LP respirators are for use with ambient pumps, which provide 6 to 20 cfm of Grade D air at pressures shown in table in Section 4.2.2. Maintaining the correct operating pressure at the point of attachment ensures the correct air flow to the respirator.

4.2.2 Use the following table to determine the minimum and maximum pressure settings and maximum

respirator hose length. Adjust the pressure with the respirator hose and respirator attached. If the regulator is adjusted with static pressure (no air flow), pressure may drop below the required pressure when the respirator is connected, and may result in low air flow. Setting the pressure as instructed will provide a minimum of 7 cfm to the respirator.

Total Hose Length	Maximum Number of Hose Sections	Pressure (psi)	
		Min.	Max.
50 feet	1	6	10
100 feet	2	8	14
200 feet	2	11	20
300 feet	3	15	20

NOTE: Use any combination of hose shown to provide a maximum of 300 ft., but not to exceed three individual hose lengths.

4.2.3 Pressure Conversion Kit

4.2.3.1 This optional accessory kit contains parts and instructions to convert an Apollo 60 respirator from low pressure (for use with an ambient air pump) to high pressure (Grade "D" Compressed Air). The kit is listed in Section 10.1.

5.0 OPERATION

WARNING

Except for emergency evacuation when the use of the respirator hinders escape, keep the respirator on and leave the respirator-use area immediately if any of the following occur:

- Any part of the respirator system becomes damaged
- Any air monitoring alarm is activated
- Air flow into the respirator is reduced or stops
- Breathing becomes difficult
- At the first sign of dizziness, nausea, fever, illness or injury
- Any contamination is noted by taste, smell or vision inside the respirator
- Vision becomes impaired
- Any irritation is noted

5.1 Prior to operation, thoroughly inspect and clean the helmet, breathing tube, respirator hose, air entry ports,

and fittings of all dust and debris. Inspect the helmet suspension and if necessary adjust it per Section 6.1.

5.2 Begin the operation of the ambient air pump per the manufacturer's instructions.

5.3 Check air pressure at the point of attachment. Set the pressure within the minimum and maximum pressures assigned in Section 4.2. Pressure must be set with the respirator connected.

5.4 Inspect all safety and breathing equipment used in conjunction with the respirator as recommended by the manufacturer.

5.5 Inspect respirator hoses and connections for tightness and leaks.

5.6 Don the respirator in a clean non-hazardous environment, free of contaminants, where the air is safe to breathe.

5.7 When donning and removing the respirator, keep it upright to prevent dust and abrasive from falling inside. Holding the chin strap while donning the helmet will make it easier to position it once the helmet is on.

5.8 Position the chin strap so it fits comfortably under the chin.

5.9 Position the knit cuff on the inner collar so that it fits snugly around the neck in turtleneck fashion, and without any interference from clothing or long hair. When correctly positioned, the smaller elastic end of the collar must face up.

WARNING

Correct placement of the inner collar is critical for providing the protection for which the respirator is designed. The collar must be positioned and maintained without any interference from items such as hair, facial hair, or shirt collars, between the inner collar and user's neck.

5.10 Pull the cape down to fully extend it and connect the four elastic straps (two on each side) under the arms, and tighten using the slides provided.

5.11 Put on the belt and constant-flow connector over the cape. Buckle the belt around the waist, and tighten it by pulling the belt end through the buckle insert.

5.12 When finished blasting, and after cleanup is completed, remove the respirator outside the respirator-use area and where the air is safe to breathe.

⚠ WARNING

Do not don the respirator, or store it in a blast contaminated environment. Do not remove the respirator in a contaminated environment except for emergency evacuation when the use of the respirator hinders escape.

NOTE: The quick disconnect coupling on the end of the respirator hose is not equipped with a shut-off. Therefore, if the hose is disconnected from the respirator while the pump is in operation, air will continue to flow freely from the hose. After removing the respirator in a clean environment, the air pump should be shut off.

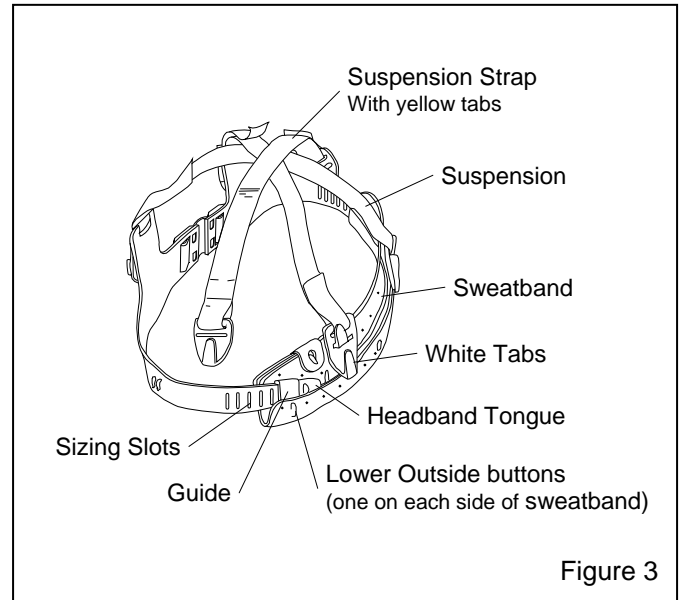

Figure 3

6.0 ADJUSTMENTS

6.1 Suspension, Ref. Figure 3

⚠ WARNING

The suspension maintains a fixed distance between the head and the helmet. It is critical that the suspension is properly installed, and adjusted as described, to provide maximum head protection and comfort.

6.1.1 Remove the cape per Section 9.4.

6.1.2 Unfasten the vinyl sweatband from the two lower, outside buttons, ref. Figure 3. It is not necessary to remove the suspension to make adjustments.

6.1.3 The suspension fits head sizes 6.5 to 8. Head sizes are marked on the headband slots. Slide the headband tongue in or out of the guide to attain the desired head size. It is important that the adjustment be made evenly on both sides. Press the selected slots firmly onto the fastening lugs on the front band.

6.1.4 Refasten the vinyl sweatband onto the suspension buttons.

6.1.5 Try on the helmet for fit and readjust if necessary.

6.1.6 Reattach the cape to the helmet by following the instructions in Section 9.4.

7.0 MAINTENANCE PROGRAM

7.1 Basic Service

7.1.1 A program for maintenance and care of the respirator must be established based on application, working conditions, and hazards involved, and include the following basic service.

- Inspection for defects (including a leak check)
- Cleaning and disinfecting
- Repair (service maintenance)
- Storage

Equipment must be properly maintained to retain its original effectiveness. Reference OSHA Regulation 29 CFR 1910.134 (h).

7.2 Inspection

Inspection must be done in compliance with OSHA Regulation 29 CFR 1910.134 (h)(3).

7.2.1 Inspect respirator before and after each use, and during cleaning. Inspection shall include a check for tightness of connections and the condition of the lenses, suspension, cape and elastic parts, breathing tube, respirator hoses and connectors, and constant-flow connector.

7.2.2 Inspect the respirator hoses, breathing tube, air entry ports, and fittings for dust contamination; make sure they are clean before making connections.

7.2.3 The helmet suspension is very important for maintaining maximum hard hat and respiratory protection. It must be inspected for fit and wear on a daily basis, and replaced immediately at the first sign of wear (See Section 6.1 for adjustment and Section 9-3 for replacement).

7.2.4 The inner collar is very important for controlling air escape from the helmet and preventing ingress of dust. The elastic collar fit snugly around the user's neck. The collar must be replaced when it no longer fits snugly around the neck.

7.2.5 The outer cape provides protection from rebounding abrasive and from abrasive ingress into the helmet. Inspect the outer cape frequently for wear. Replace the cape before holes wear through, or any wear occurs that prevents the cape from providing the protection for which it is intended.

7.3 Cleaning and Disinfecting

Cleaning and disinfecting must be done in compliance with OSHA Regulation 29 CFR 1910.134 (h)(1). See Section 8.0 for cleaning instructions.

7.3.1 A respirator issued for the exclusive use of an employee shall be cleaned and disinfected as often as necessary to be maintained in a sanitary condition.

7.3.2 Shared respirators must be cleaned and disinfected before being worn by different individuals.

7.4 Repairs (Service Maintenance)

Repairs must be done in compliance with OSHA Regulation 29 CFR 1910.134 (h)(4).

7.4.1 The employer shall ensure that respirators that fail an inspection or are otherwise found to be defective are removed from service, adjusted, repaired or discarded in accordance with the following procedures:

7.4.2 Adjustments and repairs must be made only by appropriately-trained persons, and only with genuine Clemco NIOSH-approved parts designed for the respirator. No attempt shall be made to substitute components or to make adjustment or repairs beyond the manufacturer's recommendations. See Sec. 9.0 for service instructions.

7.5 Storage

Storage of the respirator must be done in compliance with OSHA Regulation 29 CFR 1910.134 (h)(2).

7.5.1 Daily Storage

7.5.1.1 When the respirator is not in use, it must be stored in a clean, dry area. Hang the respirator by the strap provided on the top. Do not tuck the cape inside the helmet. Let the cape hang loose to allow air to circulate, and condensation on the cape and inside the helmet to dry.

7.5.2 Long-term Storage

7.5.2.1 After inspection, cleaning, and thorough drying, and after necessary repairs are made, the cape should be tucked inside the helmet. The respirator shall be placed in a plastic bag and the bag sealed to keep out dust and moisture. Place the bag in a clearly-marked carton and store it in a clean, dry place.

8.0 CLEANING AND DISINFECTING

NOTE: Unless otherwise stated all cleaning and disinfecting should be done in accordance to OSHA Regulation 29 CFR-134 App. B-2.

CAUTION

Follow washing instructions as described in this section. Do not use any caustic chemicals or solvents that may be irritating or harmful to the user, or which change the properties of the materials used in any part of the respirator.

8.1 Outer Cape

8.1.1 See Section 9.4 for removal and installation instructions.

8.1.2 Machine wash in warm water with mild detergent. Dry in a clothes dryer at the lowest temperature setting. Do not dry clean.

8.2 Inner Collar

8.2.1 The removable inner collar should be frequently washed to remove build-up of dirt that accumulates from normal perspiration and air moisture. For general hygiene, daily washing is recommended.

8.2.2 The inner collar may be either washed or replaced separately or with the outer cape. To wash separately, unzip the collar and machine wash in warm water with mild detergent. Tumble dry in a clothes dryer at the lowest temperature setting. Do not dry clean.

8.3 Sweatband and Suspension

8.3.1 Wash the sweatband, suspension, and chin strap, using warm water and mild detergent. See Section 9.3 for removing the suspension.

8.4 Helmet Assembly

8.4.1 The helmet assembly should be wiped clean with a cloth dampened with water and mild detergent. Do not immerse the helmet in water. While this will not permanently damage the helmet, it will require an extended drying period.

8.4.2 Care must be taken to prevent abrasive entry when donning and removing the respirator and when changing lenses. Vacuum the inside of the helmet to remove any abrasive.

8.4.3 If the acoustical foam on the inside of the helmet becomes soiled, it can be wiped with a damp cloth or pulled off and replaced.

8.5 Disinfecting

8.5.1 Washing the respirator as instructed also disinfects it. Additional disinfecting may be done before and/or after use by wiping the surfaces with a commercial disinfecting wipe or spray.

9.0 SERVICE MAINTENANCE

CAUTION

To prevent recontamination of the respirator, clean the respirator of dust and media before maintenance. All maintenance must be done in a clean environment away from dust and media, and outside the respirator use area.

9.1 Lens Options and Replacement Procedures Refer to Figure 4

Note: The standard helmet assembly includes one inner lens and five perforated outer lenses.

Fixed Inner Lens: Replaceable lens required by OSHA, must be used with all lens systems. Refer to Section 9.2 for replacement of fixed inner lens.

Optional Non-Perforated Intermediate lens: Protects the inner lens.

Perforated Outer Lens: Use in multiples over intermediate lens and/or fixed inner lens. For high-abrasion applications and/or the convenience of tearing off frosted lenses during the work period.

NOTE: Choose one of the following lens system options

- a. Fixed inner – no intermediate – up to five perforated outer lenses.
- b. Fixed inner – one intermediate – up to three perforated outer lenses.
- c. Fixed inner – one intermediate – no perforated outer.

9.1.1 Perforated Outer Lenses

For maximum visibility, install only enough lenses to last during a work period, but no more than five, or, no more than three when using an intermediate lens. Preparing lenses in the following manner will permit the outer lenses to be torn off while blasting to expose a fresh lens as needed, while preserving the innermost perforated lens to protect the intermediate lens.

9.1.1.1 Unlatch and open the window frame and remove remnants of old lenses.

9.1.1.2 Inspect the window gasket and inner lens. If necessary replace per Section 9.2.

9.1.1.3 Arrange the stack of lenses on the inside of the

opened window frame so the straight edge is toward the top of the frame, and the **pull-tabs are at the hinged end**, as shown in Figure 4.

9.1.1.4 Place the open slot on the latch end over the locating lug.

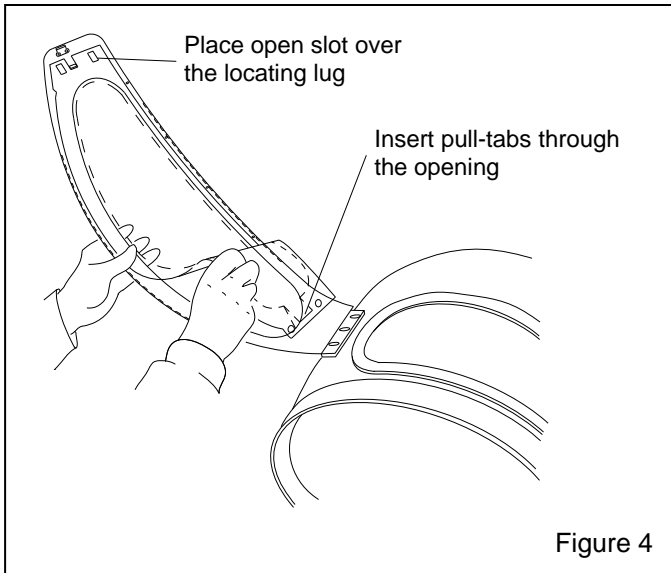

Figure 4

9.1.1.5 Insert the pull-tabs through the frame opening.

9.1.1.6 Place the pull-tab cutout over the lug on the outside of the window frame. The lens perforations should line up close to the window frame opening when the frame is closed and latched.

9.1.1.7 When using an intermediate lens, install the intermediate lens atop the perforated lenses while the window frame is open.

9.1.1.8 Close and latch the window frame to secure all lenses.

9.1.1.9 Snipping off the pull-tab on the innermost lens after the frame is closed will prevent unintentional removal of the last lens and prolong the life of the inner lens.

9.1.2 Intermediate Lens (optional)

9.1.2.1 Unlatch and open the window frame, and remove the old lens.

9.1.2.2 Inspect the window gasket and inner lens. If necessary replace per Section 9.2.

NOTE: It is not necessary to use perforated outer lenses, but they will protect the intermediate lens when rapid frosting occurs. If outer lenses are used, up to three may be installed before the intermediate lens, per Section 9.1.1.

9.1.2.3 Place the new lens on the frame with the straight edge toward the top.

9.1.2.4 Secure the lens to the frame by pressing the slots onto the locating lugs.

9.1.2.5 Close and latch the window frame.

9.2 Removing and Replacing the Inner Lens and Window Gasket

Note: The following instructions explain the method of first installing the gasket onto the helmet, and then the lens. Spraying a small amount of water or food grade silicone into the gasket grooves will reduce friction and ease installation. Alternatively, install the lens into the window gasket and then install the lens and gasket onto the helmet as an assembly.

9.2.1 Replace the inner lens when it becomes dirty or scratched.

9.2.2 Remove the outer cape to ease the installation.

9.2.3 Unlatch and open the window frame.

9.2.4 Working from inside the helmet, pull up on the window gasket lip and push out the gasket and lens through the front of the window opening.

9.2.5 Remove the old lens from the gasket.

9.2.6 Place the gasket over the window opening.

9.2.7 From the inside of the helmet, work the gasket lip onto the helmet. Smooth out wrinkles in the gasket on the inside of the helmet.

9.2.8 Insert one end of the lens into the gasket groove. The lens must be fully seated into the groove.

9.2.9 Work the lens into the groove until it is completely seated into the gasket's groove.

9.2.10 Install the intermediate and outer lenses, and latch the window frame.

9.2.11 To maximize the wear life of the inner lens, do not use without an intermediate lens. The respirator must never be used without the inner lens in place.

9.2.12 Attach the outer cape.

9.3 Removing and Replacing the Suspension

9.3.1 Remove the cape from the helmet per Section 9.4.

9.3.2 Remove and discard the old suspension and suspension strap by extracting the plastic tabs from the wedge-shaped clefts in the shell.

9.3.3 Unfasten the vinyl sweatband from the two lower, outside buttons, ref. Figure 3.

9.3.4 The suspension fits head sizes 6.5 to 8. Head sizes are marked on the headband slots. Slide the headband tongue in or out of the guide to attain the desired head size. It is important that the adjustment be made evenly on both sides. Press the selected slots firmly onto the fastening lugs on the front band.

9.3.5 Refasten the vinyl sweatband onto the suspension buttons.

9.3.6 Install the suspension strap before installing the suspension. Insert the yellow end tabs into the clefts on the helmet shell. When correctly installed, the strap is between the suspension and helmet shell and above the ears.

9.3.7 Install the suspension by inserting the four white plastic tabs into the clefts on the shell. The tabs must fully seat in their respective clefts.

9.3.8 Try on the helmet for fit and readjust if necessary. It is not necessary to remove the suspension to make adjustments.

9.3.9 Make sure the chin strap is in place, then reattach the cape to the helmet by following the instructions in Section 9.4.

9.4 Removing and Replacing the Outer Cape

9.4.1 When the cape becomes soiled or requires replacement, it can easily be removed as follows.

9.4.2 Separate the Velcro® tabs on the back of the cape. Refer to Figure 5.

9.4.3 Slide the ends of the cape to the notch. Continue sliding one end of the cape out of the groove until the entire cape is detached from the helmet.

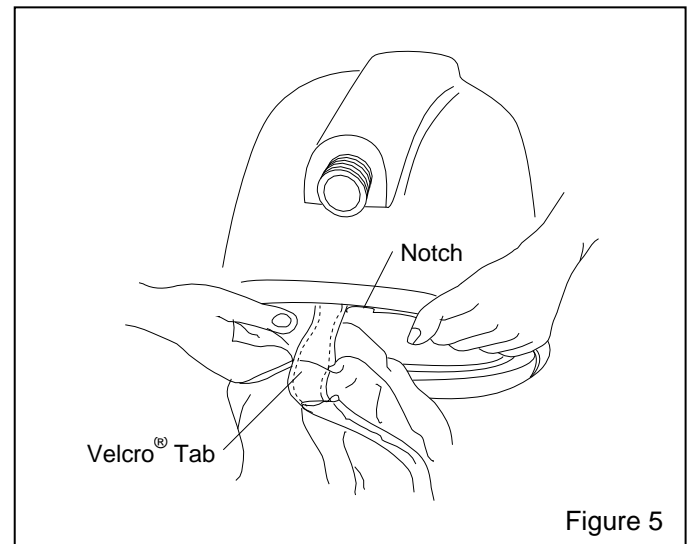

9.4.4 To install the cape, separate the Velcro® tabs on the cape and slide one end into the groove on the bottom edge of the cape attachment strap at the point where the groove is notched. Continue sliding the cape around the bottom of the helmet until the entire cape is completely into the groove. NOTE: Spraying a small amount of food grade silicone into the groove will reduce friction and ease assembly.

9.4.5 Join the Velcro® tabs at the notch.

9.5 Removing and Replacing the Inner Collar

9.5.1 The inner collar controls air escape from the helmet and prevents ingress of dust.

9.5.2 The elastic properties of the collar provide a snug fit around the user's neck. The inner collar must be replaced before it is stretched to the point where it no longer fits snugly on the user's neck. The collar unzips from the outer cape for replacement or washing. See Section 8.2 for cleaning instructions.

9.6 Window Frame and Latch

9.6.1 The window frame or latch must be replaced when it becomes difficult to maintain a seal. When replacing the window frame or latch, the acoustical foam inside the helmet should also be replaced.

9.7 Chin Strap

9.7.1 Replace the chin strap when worn or when it loses its elasticity.

10.0 REPLACEMENT PARTS

 WARNING

Use of any non-Clemco replacements parts may permit ingress of hazardous contaminants, and may cause injury, disease, or death to the user. OSHA Regulation 29 CFR 1910.134(H)(4)(i) requires the use of the respirator manufacturer's NIOSH-approved parts designated for the respirator. Using any parts listed in this section made by any manufacturer other than Clemco voids the NIOSH approval, and voids Clemco's warranty.

10.1 Supplied-Air Respirator Systems and Accessories

Respirators Systems

Description	Stock No.
Apollo 60 LP Respirator less respirator hose	22081
Apollo 60 LP Respirator with 50-foot respirator hose	22082

Accessories

Description	Stock No.
Constant-flow connector, LP with belt	21777
Pressure conversion kit, LP to HP Converts Apollo 60 LP, low pressure (ambient air) respirator to high pressure (Grade "D" Compressed Air) respirator	22080
Hearing protection muffs, Low profile noise reduction muffs May not work with all head sizes	23886
Do-rag, washable head scarf	23814
CMS-3 CO monitor package	24612

10.2 Respirator Replacement Parts, Figure 6

Item	Description	Stock No.
1.	Constant-flow connector, LP w/o belt	21429
2.	Belt assembly with buckle, 2"	04430
3.	Respirator hose, 1/2" x 50 ft. (alternate)	22510
	1/2" x 100 ft. (alternate)	21413
4.	Acoustical foam kit, both sides	04369
5.	Gasket, window	04452
6.	Inner lens, .040" package of 5	04367
7.	Intermediate lens, .020", package of 5	24943
	package of 25	04373

8.	Outer lens, .0075", perforated, package of 25	04361
9.	Window frame kit	08741
10.	Chin strap	04460
11.	Handle strap	03623
12.	Suspension	10532
13.	Cape attachment strap	10534
14.	Cape, red, with item 17 inner collar	04435
15.	Breathing tube assembly includes two of item 16	22811
16.	O-Ring, 7/8" OD, 2 required	22815
17.	Inner collar	08740
18.	Window latch kit	04368

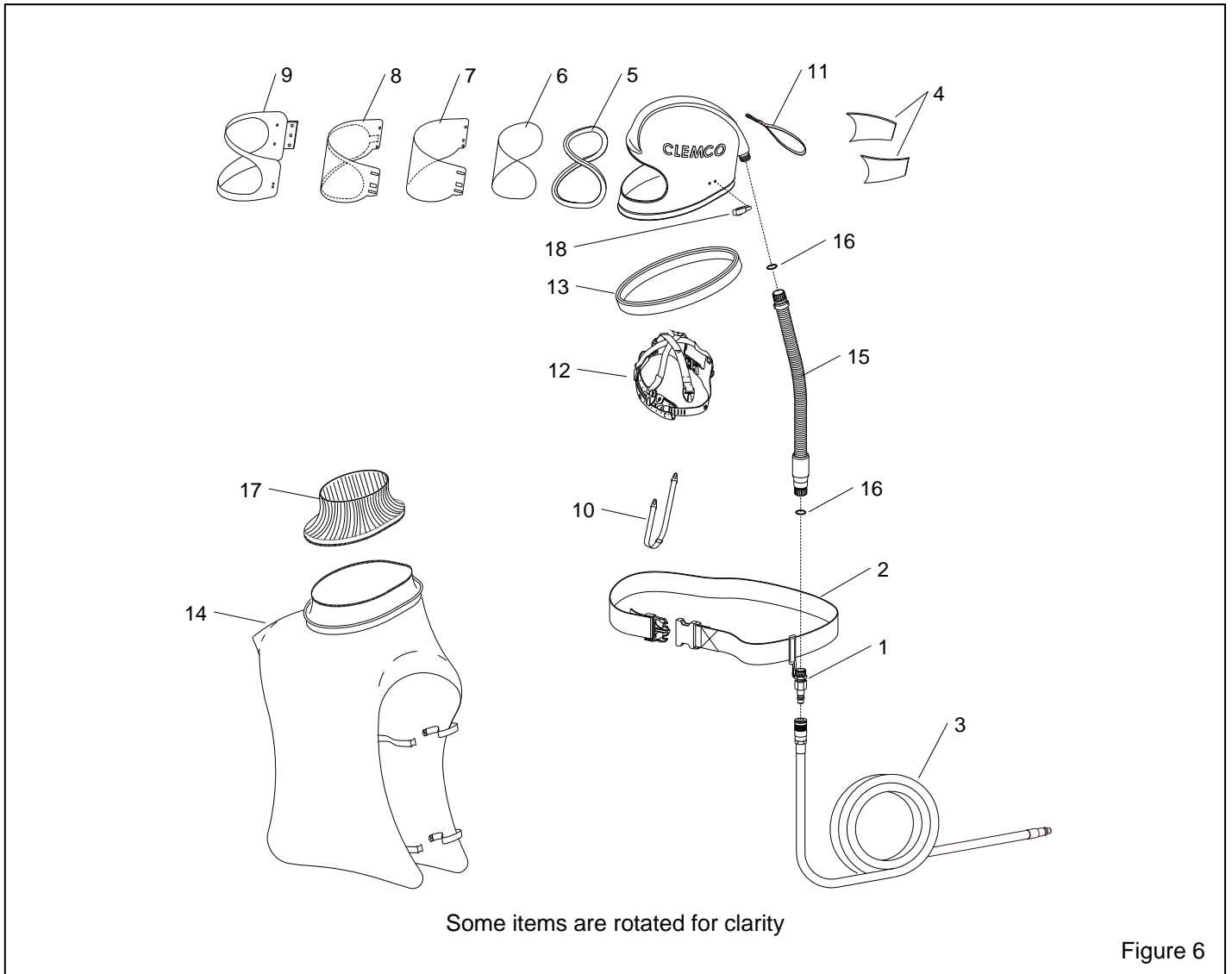

Figure 6